



IRay Technology Co., Ltd.

Add: 11th Guiyang Street, YEDA, Yantai, P.R. China

Tel: 0086-400-998-3088

Email: infraredoutdoor@infrared.com

Web: www.infraredoutdoor.com

www.infraredoutdoor.com

Infiray Outdoor • Geni Series • Operating Manual

Operating Manual

V1.0

Geni Series | Thermal Imaging
Scope

GL35R

IMPORTANT SAFETY INFORMATION

Environmental influences

Note: Never point the lens of the device directly at intense heat sources such as the sun or laser equipment. The objective lens and eyepiece can function as a burning glass and damage the interior components.

Risk of swallowing

Caution: Do not place this device in the hands of small children. Incorrect handling can cause small parts to come loose which may be swallowed.

Safety instructions for use

- Do not expose the device to fire or high temperatures.
- The battery capacity decreases when operated in a cold ambient temperature. This is not a fault and occurs for technical reasons.
- Always store the device in its carrying bag in a dry, well-ventilated space. For prolonged storage, remove the batteries.
- Do not expose your device to extreme temperatures lower than - 20°C and higher than + 50°C.
- The product shall only be connected to a USB Type C interface.
- If the device has been damaged or the battery is defective, send the device to our after-sales service for repair.

User information on the disposal of electrical and electronic devices (private households)



The WEEE symbol on products and/or accompanying documents indicates that used electrical and electronic products must not be mixed with ordinary household waste. For proper treatment, recovery and recycling, take these products to the appropriate collection points where they will be accepted without charge. In some countries, it may also be possible to return these products to your local retailer when you purchase a corresponding new product. The proper disposal of this product serves to protect the environment and prevents possible harmful effects on human beings and their surroundings, which may arise as a result of incorrect handling of waste.

More detailed information on your nearest collection point is available from your local authority. In accordance with state legislation, penalties may be imposed for the improper disposal of this type of waste.

For business customers within the European Union

Please contact your dealer or supplier regarding the disposal of electrical and electronic devices. He will provide you with further information.

Information on disposal in other countries outside of the European Union

This symbol is only applicable in the European Union. Please contact your local authority or dealer if you wish to dispose of this product and ask for a disposal option.

without glasses. It offers a full field of view in both cases.

Intended use

The device is intended for displaying heat signatures during nature observation, remote hunting observations and for civil use. This device is not a toy for children.

Use the device only as described in this instruction manual. The manufacturer and the dealer accept no liability for damages which arise due to non-intended or incorrect use.

Function test

- Before use, please ensure that your device has no visible damage.
- Test to see if the device displays a clear, undisturbed image.
- Check that the settings for the thermal imaging camera are correct. See the notes in the section Observation mode.

Installing/removing the battery

The Geni thermal imaging scope need to install one 26650 battery for use. Refer to the section Battery Installation for details.

Observation with and without glasses

Thanks to the flexible eyeshade, the Geni series can be used with or

1 Specification

Model	Geni GL35R
Microbolometer	
Resolution, pixels	384 × 288
Pixel size, μm	12
NETD, mk	≤40
Frame rate, Hz	50
Optical Characteristics	
Objective lens, mm	35
Field of view	7.5° × 5.7°
Magnification, x	2.81 - 11.24
E-zoom, x	1 / 2 / 3 / 4
Diopter Adjustment, D	-5 ~ +5
Detective range, m (Target size:1.7m*0.5m, P(n)=99%)	1818
Display	
Display type	OLED
Resolution, pixels	1024 × 768
Power Supply	
Battery type	26650 × 1
External Power Supply	5V (Type C USB)

Max. Operation time (at t=22°C), h*	7
Operational Characteristics	
Max. Recoil Power on Rifled Weapon, g/s ²	1000
Degree of protection, IP code	IP67
Amount of built-in memory, Gb	32
Operating Temperature Range, °C	-10 ~ +50
Weight (without batteries), g	< 600
Dimension, mm	225 × 100 × 61.5
Rangefinder Characteristics	
Wavelength, nm	905
Max. Measuring Range, m/y**	1000
Measurement Accuracy, m	±1

- * The actual operating time depends on the intensity of using Wi-Fi, video recorder.
- ** The measuring range depends on the characteristics of the object under observation and environmental conditions.
- Improvements may be made to the design and software of this product to enhance its useful features.
- Technical parameters of the device may be improved without prior notice of the customer.

2 Package Contents

- GL35R Thermal Imaging Scopes
- IRM-030-205-Q1 picatinny mount
- A L-shaped wrench
- M5 screw × 4 pcs
- Portable bag
- Lens cloth
- Heated target for zeroing × 5pcs

3 Description







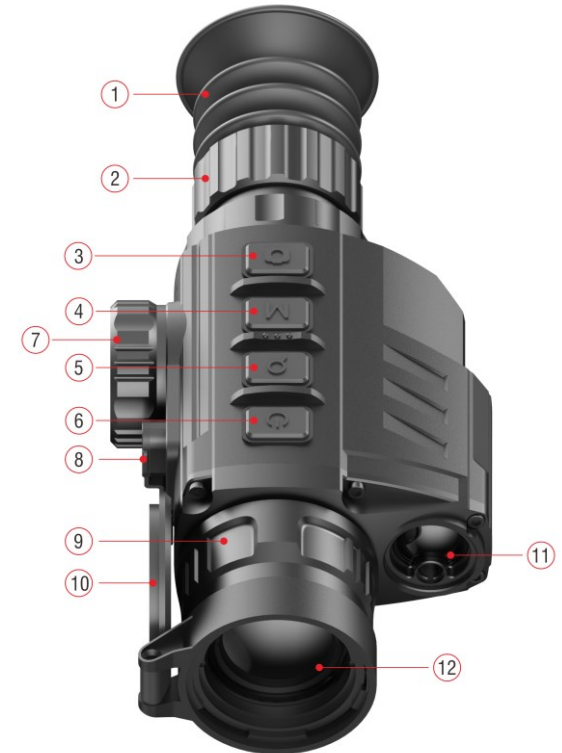











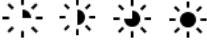

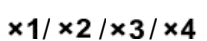









The Geni series GL35R is an infrared thermal imaging scope with a built-in laser rangefinder. It can be installed on various types of firearms for night hunting. It is light in weight, small in size, and easy to carry, and features a long working time, good concealment, and strong penetration of thick smoke, dust, or night.

4 Components and Controls

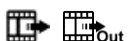



1. Eyeshade
2. Eyepiece diopter adjusting ring
3. Camera (C) button
4. Menu (M) button
5. Zoom (Z) button
6. Power (P) button
7. Battery compartment
8. Type C port
9. Lens focus ring
10. Lens cover
11. Laser rangefinder
12. Objective lens



5 Icons Instructions

	Image mode: White hot		Motion sensor
	Image mode: Black hot		Microphone
	Image mode: Red hot		Image hue
	Image mode: Color		Zeroing type * G1 * G2 * G3 * G4
	Display brightness		More
	E-zoom		Zeroing
	Image sharpness		Defective pixels calibration
	Image brightness		Compass calibration
	Image contrast		Laser rangefinder calibration
	Ultraclear mode		Time setting
	Wi-Fi		System information
	Auto correction mode		Factory reset
	Video out		Return to the Main Menu
	PIP		Battery indicator
	Digital compass		USB icon

6 Description of Controls

Button	Status / Current Operation Mode	Short Press	Long Press
P (Power) Button 	Device is off	—	Power on the device
	Device is on	Turn the standby mode on/off	Power off the device
	Rangefinder Mode	Exit and return to the home screen	—
	Menu and function interface	Exit to the upper interface without saving	—
Z (Zoom) Button 	Home Screen	Digital Zoom	Enter the rangefinder mode
	Main menu / Shortcut menu interface	Navigation upwards	—
	Single rangefinder Mode	Distance measurement	Switch rangefinder mode
M (Menu) Button 	Home screen	Enter the shortcut menu	Enter the main menu
	Shortcut menu	Switch to the next page of the shortcut menu	—
	Main menu	Enter the submenu / Confirm selection	Save and exit to the upper interface
	Defective pixel calibration	Switch the moving direction	
C (Camera) Button 	Home screen	Take a Photograph	Start video recording
	Main menu / shortcut menu	Navigation downwards	—
	Video recording	Take a Photograph	Stop and save video
M + C Buttons	Home screen	Shutter correction	Background correction
Z + M + C Buttons	Home screen	Switch the units between cm/m and inch/yard	—

7 Battery Installation

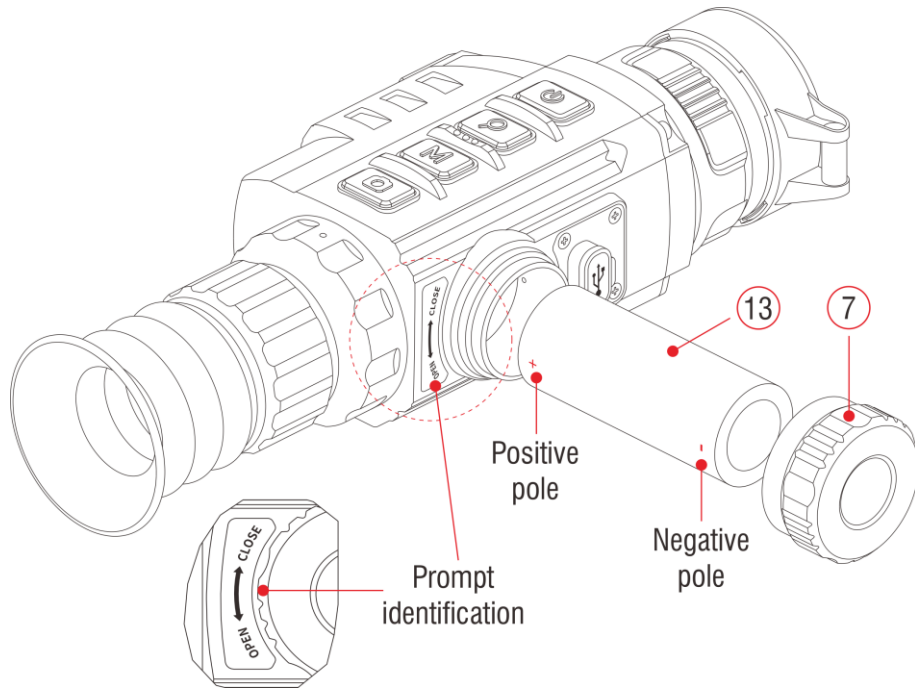

- Open the battery cover (7) anticlockwise according to the prompt identification on the device.
- Place one 26650 battery (13) correctly according to the polarity labels in the battery compartment.
- When done, screw tightly the battery cover (7) clockwise.

Attention

- Please use batteries provided by formal manufacturers.
- Geni series can also be connected to an external power supply through the Type-C data cable. In this case, the USB icon  is displayed on the upper right of the screen.

8 Operation

- Open the lens cover (10).
- Press and hold down the **Z (5)** button for 3s to power on the device. Wait for 6s until thermal image appears on the display.
- **Diopter Adjustment:** Adjust the sharp resolution of the icons on the display by rotating the diopter adjusting ring (2) of the eyepiece.
- **Lens Focus Adjustment:** rotate the lens focus ring (9) to focus on the object being observed.
- **Calibration:** in the home screen, calibrate the image with a short press of the **M (4) + C (3)** buttons for shutter calibration or long press the **M (4)** and **C (3)** button for background calibration.

- **Image Settings:** adjust the image mode, display brightness, digital zoom, image sharpness, image brightness, image contrast in the shortcut menu (for more details, see the **Shortcut Menu** section).
- **Standby Mode:** Briefly press the **P (6)** button to turn the standby mode on/off. The standby mode can
- **Power off:** to power off the device, long press **P (6)** button for 5s until the shutdown option menu appears. Make your selection to switch “√” or “x” with a short press of the **Z (5) / C (3)** button and confirm your selection with the **M (4)** button. Select the “√” to shut down and “x” to cancel.
- **Reticle On:** click the **M (4)** button four times in a row while pressing and holding the **Z (5) + C (3)** button to invoke the reticle function for the first time use, then long press the **Z (5) + M (4) + C (3)** button simultaneously for 7 seconds to turn the reticle on. This function should be activated when the reticle first enabled.



Attention

- When the reticle is turned off, all the operations related to it in the menu will be hidden, including the adjustment of the reticle color and pattern (in the shortcut menu), the options of zeroing and blind pixel correction in the main menu.

9 Zeroing

Zeroing is recommended to be done at the temperature close to the scope operating temperature.

Before implementing zeroing setting, please make sure that the reticle is on and zeroing type is selected in the main menu.

- Mount the scope on your weapon.
- Set a target at 100m distance, and power on the scope.
- For the first use of the scope, please make sure that the reticle is on before zeroing (refer to the instructions of section 6 **Operation**).
- Long press the **M (4)** button on the home screen to enter the main menu.

- Select one zeroing type in the main menu (refer to the **Main Menu – Zeroing Type**).
- Select the Zeroing item in the submenu of the **MORE** item, and press the **M (4)** button to enter the Zeroing interface. In the Zeroing interface, the reticle is shown as a small cross for position adjustment.
- Then aiming the center of the reticle at the bull's-eye 100 meters away and shooting.
- After firing, observe the actual point of impact.
- **If the bullet hole can be seen on the display of the thermal scope:**

- While keeping the position of the device fixed, press and hold the **M (4)** and **C (3)** button at the same time to freeze the image, and a snowflake icon ❄ will appear on the upper-left corner of the screen.

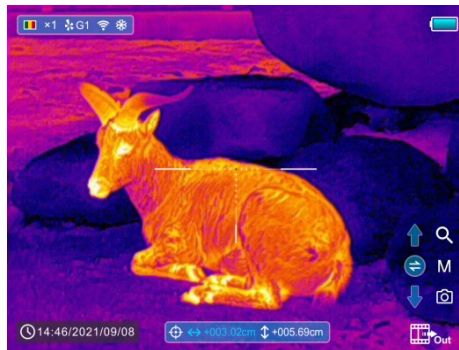

- Move the reticle to the position of the actual impact point by the **Z (5) / C (3)** button.
- Short press the **M (4)** button to switch the movement direction

between UP-DOWN and RIGHT-LEFT.

- After moving the reticle to the bullet hole, press and hold down the **M (4)** button to save the position and exit.
- **If the bullet hole cannot be seen on the display of the thermal scope:**
 - Keep the position of the device fixed, and measure the horizontal and vertical distance between the bull's eye and the bullet hole.
 - According to the measured distance, move the reticle position by long or short pressing the **Z (5) / C (3)** button until the distance marked on the scale plate consistent with the measured distance.
 - Short press the **M (4)** button to switch the movement direction between UP-DOWN and RIGHT-LEFT.
 - Press and hold down the **M (4)** button to save and exit when the process is done.

Notes

- To ensure the accuracy of the position, aiming the bull's-eye again and repeat the operations until the bull's-eye is hit.
- In the zeroing interface, the reticle moves one pixel with a short press of the **Z (5) / C (3)** button to the corresponding direction while ten pixels

movement with a long-pressing. One pixel means to move 1.29cm at a distance of 100 meters or 0.46 inches at a distance of 100 yards.

- Press the **Z (5) + M (4) + C (3)** buttons briefly at the same time to switch units (cm/m, inch/yard).
- In the zeroing interface, there is a white dot that represents the original position of the reticle before calibration implement.
- After zeroing, the center of all reticle will be changed accordingly.

10 Calibration

Calibration enables to equalize the detector temperature and eliminate the image defects (such as vertical bars, phantom images, etc.). There are two calibration way – auto or manual.

- In the main menu, you can turn the **Automatic Shutter Calibration** on/off (referring to the **Main Menu – Auto Shutter Calibration**). When the automatic calibration is on, the scope will calibrate automatically according to the software algorithm. There is no need to close the lens cover (the internal shutter covers the sensor). Before automatic calibration, there will be a 5 second countdown prompt behind the

shutter icon on the status bar, that can be to cancelled this calibration during countdown with a short press of the **P (6)** button.

- Whether the automatic calibration is turned on or off, user can also manually calibrate the sensor. In the home screen, short press the **M (4) + C (3)** buttons at the same time to finish the shutter calibration without closing the lens cover (the internal shutter covers the sensor), meanwhile, press and hold down the **M (4) + C (3)** buttons at the same time to perform the background calibration, that a prompt of closing the lens cover appears on the display and background calibration starts after 2s.



11 Digital Zoom

Geni series support to quickly increase the basic magnification by 2 times, 3 times or 4 times, as well as to return to the basic magnification.

- In the home screen, briefly press the **Z (5)** button to operate the incremental digital zoom in loop to switch magnification times. At the same time, the icon in the top status bar changes accordingly.
- Also, you can select the digital zoom in the shortcut menu (referring to the second page of the shortcut menu).

12 Photographing and Video Recording

Geni series thermal imaging scope is equipped with a function for video recording and photographing observed images onto the built-in memory card. The files of images and videos will be named after the time, so it is recommended to reset the system time in the **Main Menu – More - Time Setting** or to synchronize the system time and date in the Settings of the APP **InfiRay Outdoor** before using the camera and video function. For specific operations.

Photographing

- Take a photo with a short press of the **C (3)** button in the home screen.
- A camera icon () shows in the upper-right of the screen and the image will freeze for 0.5s when the function performs.

Video recording

- Press and hold the **C (3)** button in the home screen to start the video recording.
- A tooltip showing the recording time in MM: SS (minutes: seconds) format will appear in the upper right corner of the display.



- The red dot in the tooltip flashes during recording.
- During recording, short press the **C (3)** button to take a photo also.
- Press and hold the **C (3)** button again to exit the recording when done.
- Video and picture files are stored in the built-in memory card after video recording has been turned off. But the video will not be saved if you skip the process and shut down the device suddenly instead.

➤ The photos and videos can be read on the computer via the USB cable.

Note

- Notice that the recorded video cannot be saved if you directly shut down or power off the device other than long pressing the **C (3)** button to exit
- You can enter and work on the menu during video recording.
- The recording time is accumulated in minutes until the recording stops, that is, the time shows 60:00 after 59:59.
- The maximum duration of a video recording file is 10 minutes. When it's more than 10 minutes, the video will be recorded onto a new file.
- The number of files is limited by the capacity of the device's built-in memory. Regularly monitor the amount of free memory in the built-in memory card, transferring footage and photos to other media to free up space on the memory card.

Memory Access

When the device is turned on and connected to a computer, it is recognized by the computer as a flash memory card, which is used to

access the device's memory and make copies of pictures and videos.

➤ Turn on the device and connect it to the computer through the USB cable.

➤ Double-click "my computer" on the desktop - double-click to open the device named "InfiRay"



InfiRay

- then click and open the device

named "Internal Storage"



Internal Storage

14.6 GB 可用, 共 14.6 GB

to access

memory.

- There are different folders named by time in memory.
- Recorded videos and photographs are saved in these folders in the format: IMG_HHMMSS_XXX.jpg (for photos) and VID_HHMMSS.mp4 (for video). HHMMSS- hour/minute/ second; XXX - three-digit common file counter for photos which is NOT reset.

13 Laser Rangefinder Function

- In the home screen, press and hold the **Z (5)** button to turn the laser rangefinder function on/off.

- The ranging cursor  appears on the screen. The rangefinder information is displayed under the battery level in the upper right corner of the screen, including the measurement value and ranging mode.

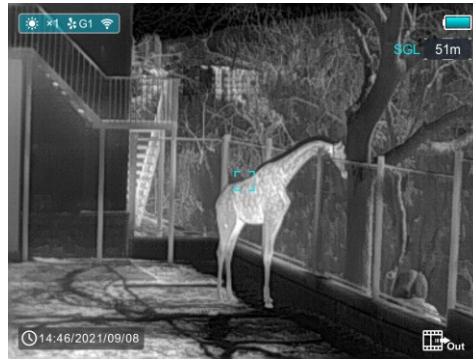

- Geni GL35R series has two ranging modes: **SGL** (single ranging) and **CONT** (Continuous ranging). Press and hold down the **Z (5)** button to switch between the SGL (the factory default mode) and CONT mode.
- In the **SGL** mode, briefly press **Z (5)** button to measure the distance of the target pointed by the cursor.
- In the **CONT** mode, the rangefinder information in the upper right corner will be updated per second in real time automatically according to the selected object without any keystroke operation.
- When ranging targets is further than 1000m, the **MAX** will appear in the ranging values.
- Briefly press the **P (6)** button to exit the laser rangefinder function.

Peculiarities of Laser Rangefinder

- The accuracy measurement and maximum range depend on the reflection ratio on the target surface, the angle at which the emitting beam falls on the target surface and environmental conditions. Reflectivity is also by surface texture, color, size and shapes of the object. Usually, a glossy and bright surface presents higher reflectivity than a darker surface.
- Accuracy of measurement can also be affected by illumination condition, fog, smog, rain, snow etc. Ranging performance can degrade in bright condition or when ranging towards the sun.
- Measuring range to a small side target is more difficult than a large size target.

14 Shortcut Menu

The basic settings (image palette, display brightness, digital zoom, image sharpness, image brightness and contrast, reticle color and pattern) can be changed using the shortcut menu.



- In the home screen, short press the **M (4)** button to enter the shortcut menu.
- There are four pages (when the reticle function is invoked) and two functions on each page, one at the top and one at the bottom.
- On each page, press the **Z (5)** button briefly to switch the options of the top function, and press the **C (3)** button briefly to switch the options of

the bottom function. And each function has four options

- Press the **M (4)** button briefly to switch the next page.
- Briefly press the **P (6)** button to exit the shortcut menu.

Shortcut Menu Options and Descriptions

Times of pressing the M (4) button	Shortcut Menu	Interface	Operation
1 time	Enter the first page of the shortcut menu to adjust the image palette and screen brightness		<ul style="list-style-type: none"> ➤ Short press the Z (5) button to adjust image palette among white hot, black hot, red hot and color. ➤ Short press the C (3) button to adjust the image brightness level from 1 to 4 gradually enhanced.

<p>2 times</p>	<p>Enter the second page of the shortcut menu to adjust E-zoom and image sharpness</p>		<ul style="list-style-type: none"> ➤ Short press the Z (5) button to perform E-zoom parameter x1, x2, x3 and x4. ➤ Short press the C (3) button to adjust the image brightness level from 1 to 4 gradually enhanced.
<p>3 times</p>	<p>Enter the third page of the shortcut menu to adjust the image brightness and image contrast</p>		<ul style="list-style-type: none"> ➤ Short press the Z (5) button to cyclically adjust the image brightness level from 1 to 4 gradually enhanced. ➤ Short press the C (3) button to adjust the image brightness level from 1 to 4 gradually enhanced.

<p>4 times</p>	<p>Enter the fourth page of the shortcut menu to adjust reticle color and reticle pattern</p>		<ul style="list-style-type: none"> ➤ Short press the Z (5) button to adjust the reticle color: white, black, red and green. ➤ Short press the C (3) button to select the reticle pattern. There are 8 patterns for selection.
<p>5 times</p>	<p>Exit to the home screen</p>		<p>—</p>



15 Main Menu

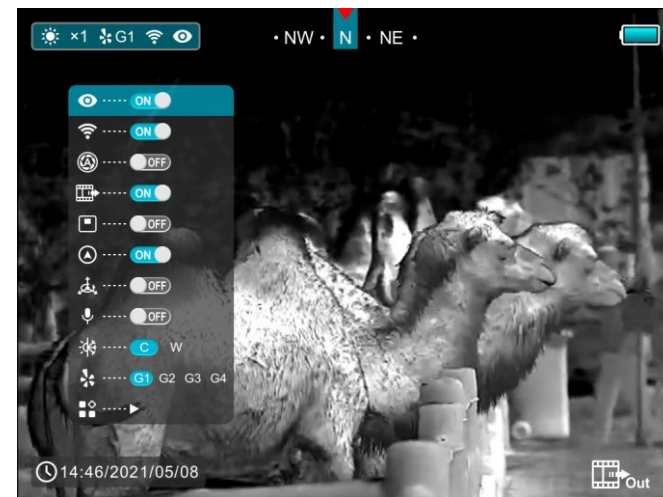

- In the home screen, press and hold the **M (4)** button to enter the main menu, which including Ultraclear mode, Wi-Fi, auto shutter correction, video output, PIP, compass, motion sensor, microphone, image hue, zeroing type and more.
- Press the **Z (5)** / **C (3)** button to move through the main menu items.
- Press the **M (4)** button briefly to set up the item parameter or to enter the function interface.



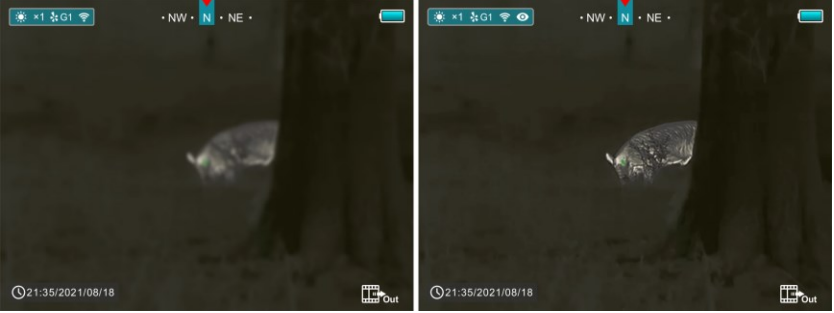

- Long press the **M (4)** button to exit the main menu.





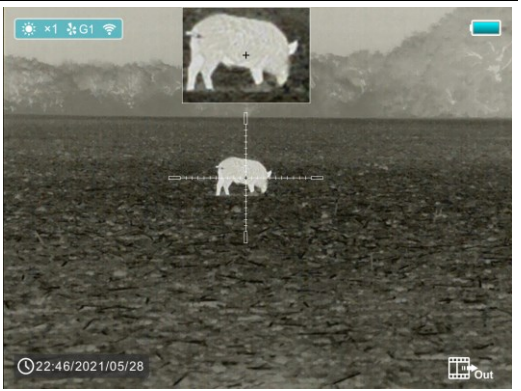



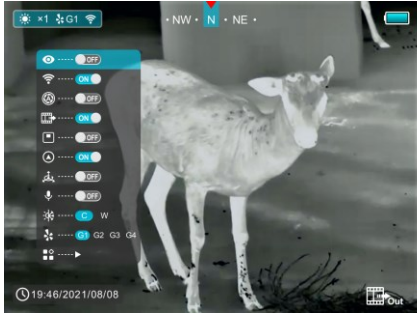
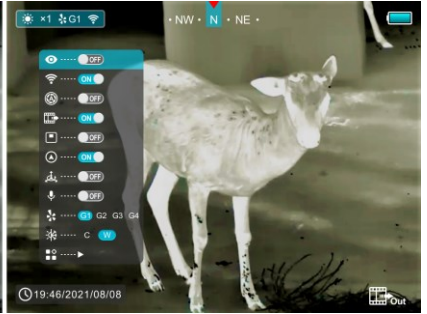

Main Menu Options and Descriptions

<p>Ultraclear</p> 	<p>Turn Ultraclear mode on/off</p> <ul style="list-style-type: none">➤ Press and hold down the M (4) button to enter the Main Menu.➤ Select the Ultraclear menu option with the Z (5) / C (3) button.➤ Turn Ultraclear mode on /off with a short press of M (4) button, along with the sound of shutter calibration.➤ The icon will be displayed on the status bar in the upper left corner of the screen when the Ultraclear mode is on.➤ Under heavy fog, rain or snow weather, Ultraclear Mode will show more image details.	
<p>Wi-Fi</p> 	<p>Turn Wi-Fi function on/off</p> <ul style="list-style-type: none">➤ Press and hold down the M (4) button to enter the Main Menu.➤ Select the Wi-Fi menu option with the Z (5) / C (3) button.➤ Turn Wi-Fi function on /off with a short press of M (4) button.➤ The icon will be displayed on the status bar in the upper left corner of the screen when the wi-Fi is on.	

<p>Auto shutter correction</p> 	<p>Turn the auto shutter correction on/off</p> <ul style="list-style-type: none"> ➤ Press and hold down the M (4) button to enter the Main Menu. ➤ Select the Auto Shutter Correction menu option with the Z (5) / C (3) button. ➤ Briefly press of the M (4) button to turn the auto shutter correction on /off. ➤ The icon will be displayed on the status bar in the upper left corner of the screen when the auto shutter correction is on. ➤ Before automatic calibration, there will be a 5 second countdown prompt behind the shutter icon on the status bar, that can be cancelled this calibration during countdown with a short press of the Power (3) button. 	
<p>Video Output</p> 	<p>Turn video output on/off</p> <ul style="list-style-type: none"> ➤ Press and hold down the M (4) button to enter the Main Menu. ➤ Select the Video Output option with the Z (5) / C (3) button. ➤ Briefly press of the M (4) button to turn video out on/off. ➤ The icon will be displayed on the lower right corner of the screen when the video output function is on. ➤ Video out function enable connectivity with an external display or recording device. 	

<p style="text-align: center;">PIP</p> 	<p>Turn Picture-in-Picture on/off</p> <ul style="list-style-type: none"> ➤ Press and hold down the M (4) button to enter the Main Menu. ➤ Select the PIP option with the Z (5) / C (3) button. ➤ Briefly press of the M (4) button to turn PIP on/off. ➤ When the PIP function is on, a small window will appear on the top of the display. 	
<p style="text-align: center;">Compass</p> 	<p>Turn on/off the digital Compass function</p> <ul style="list-style-type: none"> ➤ Press and hold down the M (4) button to enter the Main Menu. ➤ Select the Compass menu option with the Z (5) / C (3) button. ➤ Briefly press of the M (4) button to turn the digital compass on/off. ➤ When the compass function is turned on, it will reveal in the center of top status bar. 	
<p style="text-align: center;">Motion Sensor</p> 	<p>Turn on/off the motion sensor</p> <ul style="list-style-type: none"> ➤ Press and hold down the M (4) button to enter the Main Menu. ➤ Select the Motion Sensor menu option with the Z (5) / C (3) button. ➤ Briefly press of the M (4) button to turn the motion sensor on/off. ➤ Two scales are displayed on the right sides of the screen when the motion sensor is on. ➤ The horizontal scale shows tilt angle, and the vertical one shows pitch angle. 	
<p style="text-align: center;">Microphone</p>	<p>Turn on/off the microphone</p>	

	<ul style="list-style-type: none"> ➤ Press and hold down the M (4) button to enter the Main Menu. ➤ Select the Microphone option with the Z (5) / C (3) button. ➤ Briefly press of the M (4) button to turn the Microphone function on/off. ➤ The icon will be displayed on the status bar in the upper left corner of the screen when the Microphone is on.
<p style="text-align: center;">Image hue</p> 	<p>Select the image hue</p> <ul style="list-style-type: none"> ➤ Press and hold down the M (4) button to enter the Main Menu. ➤ Select the Image Hue option with the Z (5) / C (3) button. ➤ Briefly press of the M (4) button to select C or W. C is for cool hue, and W is for warm hue. <div style="display: flex; justify-content: space-around;">   </div>
<p style="text-align: center;">Zeroing Type</p> 	<p>Select the zeroing type</p> <ul style="list-style-type: none"> ➤ Press and hold down the M (4) button to enter the Main Menu. ➤ Select the Zeroing Type option with the Z (5) / C (3) button. ➤ There are four types for selection. ➤ Briefly press of the M (4) button to select one zeroing type. 
<p style="text-align: center;">More</p> 	<p>Enter the secondary menu for more settings</p> <ul style="list-style-type: none"> ➤ Press and hold down the M (4) button to enter the Main Menu. ➤ Select the More menu option with the Z (5) / C (3) button.





<p>➤ Briefly press of the M (4) button to enter the secondary menu for more settings, including zeroing, rangefinder calibration, defective pixels calibration, compass calibration, time setting, system information, factory reset and return to the main menu.</p>	
<p>Zeroing</p> 	<p>Zero your device</p> <p>Geni series support the 100m zeroing distance. To zero your scope, you need to set a zeroing type first.</p> <ul style="list-style-type: none"> ➤ Select the Zeroing option with the Z (5) / C (3) button in the More submenu. ➤ Briefly press of the M (4) button to enter the zeroing interface. ➤ Then aim the center of the reticle at the bull's-eye 100 meters away and shoot. ➤ Locate the bullet hole after shot. ➤ Then, zero your scope according the Section Zeroing. ➤ Press and hold the M (4) button to save and exit to the More submenu. 
<p>Rangefinder Calibration</p> 	<p>Calibrate the rangefinder cursor</p> <p>Generally, the scope will carry out rangefinder calibration before leaving the factory, and there is no need to carry out correction for 1000 times of impact, but if the calibration is needed, you can refer to the following method:</p> <ul style="list-style-type: none"> ➤ Select the Rangefinder Calibration option with the Z (5) / C (3) button in the More submenu. ➤ Briefly press of the M (5) button to enter the rangefinder calibration interface.





		<ul style="list-style-type: none"> ➤ If you do not have professional equipment for calibration, find a building 100m away with a great distance between the front and rear (such as a large building in open areas). ➤ Move the device slowly from left to right so that the building appears in the eyepiece gradually. In the meantime, observe the rangefinder data in the upper right corner. When finding the critical point of the rangefinder data changing, such as the point changing from —m to the measured number, press the Z (5) / C (3) button to move the rangefinder cursor left / right to the boundary between the building and the background to complete the calibration of the left and right positions. ➤ Use the same operation above to complete the calibration of the up and down positions. ➤ Briefly press of the M (5) button to switch the movement direction of the cursor. ➤ After calibration, press and hold down the M (5) button to save and exit to the More submenu.
	<p style="text-align: center;">Pixels Defect Calibration</p> <div style="text-align: center;">  </div>	<p>Calibrate the defective pixels</p> <p>Defect pixels are pixels that do not change brightness compare with others on the image, they are either brighter or darker than surrounding pixels. Geni series offer the possibility of removing any defective pixels on the sensor using software, as well as to cancel any deletion.</p>



- Select the **Pixels Defect Calibration** option with the **Z (5) / C (3)** button in the **More** submenu.
- Briefly press of the **M (4)** button to enter the pixels defect calibration interface.
- A small cross cursor instead of the reticle will appear on the center of the screen.
- The Picture in Picture (PIP) window will appear on the lower left corner of the screen. A tooltip is appeared on the bottom of the screen that displays the number of the blind pixels calibrated, the movement direction and location.
- Move the cursor to align with the defective pixel with a short or long press the **Z (5) / C (3)** button. Short press to move one pixel every time and long press to move ten pixels once.
- Switch the movement direction with a short press of the **M (4)** button.
- After selecting the blind pixel, long press **Z (5) + C (3)** button to calibrate the defective pixel, and press the same button again for cancelation.
- Repeat the above processes until all blind pixels are calibrated.
- Press and hold the **M (4)** button to save the calibration and exit to the **More** submenu.



<p style="text-align: center;">Compass Calibration</p> 	<p>Calibrate the digital compass</p> <ul style="list-style-type: none"> ➤ Select the Compass Calibration option with the Z (5) / C (3) button in the More submenu. ➤ Briefly press the M (4) button to enter the Compass Calibration interface. ➤ An icon like a triaxial coordinate system appears on the screen. ➤ Follow the icon prompt to rotate the scope along three axes at least 360 degrees each axis in the 30 seconds. ➤ After 30s, the calibration is finished and exit to the home screen. 	
<p style="text-align: center;">Time Setting</p> 	<p>Reset the system date and time</p> <ul style="list-style-type: none"> ➤ Select the Time Setting option with the Z (5) / C (3) button in the More submenu ➤ Briefly press the M (4) button to enter the time Setting interface. ➤ The order from left to right is year, month, day, hour and minute. And the time format is in 24-hours format. ➤ Switch among year, month, day, hour and minute with a short press of the M (4) button. The selected item will turn blue and two triangle icons will appear above and below the value. ➤ Select the correct value with a short press of the Z (5) / C (3) button. 	

		<ul style="list-style-type: none"> ➤ Save settings and exit to the More submenu with a long press of the M (4) button.
	<p>System Information</p> 	<p>Show device information</p> <ul style="list-style-type: none"> ➤ Select the System Information menu option with the Z (5) / C (3) button in the More submenu. ➤ The relevant information of scope will be shown by a short press of the M (4) button. ➤ This item allows the user to view the following information about the scope: the product model, GUI version, SYS Info, Boot version, FPGA, PN and SN number of the scope, Hardware version. ➤ Press and hold the M (4) button to return to the submenu. 
	<p>Factory Reset</p> 	<p>Reset to the Factory Settings</p> <ul style="list-style-type: none"> ➤ Select the Factory Reset option with the Z (5) / C (3) button in the More submenu. ➤ A prompt box will appear on the screen with a briefly press of the M (4) button. ➤ Short press the Z (5) / C (3) button to select the option. The “√” is to reset to the default, and the “x” is to cancel and exit to the More submenu. ➤ Confirm the selection with a short press of the M (4) button. 

	Return 	Return to the main menu <ul style="list-style-type: none">➤ Select the Return option by Z (5) / C (3) button.➤ Short press the M (4) button to return to the main menu.
--	--	--

16 PIP Function

- In the home screen, press and hold down the **M (4)** button to enter the Main Menu.
- Select the **PIP** option with the **Z (5) / C (3)** button.
- Briefly press of the **M (4)** button to turn PIP on/off.
- When the PIP function is on, a small window will appear on the top of the display.
- The image in the small window is a 2x magnified image centered by the reticle center.
- When the main image is enlarged through **Z (5)** button, the PIP image will be enlarged 2× synchronously.

17 Wi-Fi Function

The device is equipped with wireless communication with external devices (computer, smartphone) via Wi-Fi.

- In the home screen, press and hold the **M (4)** button to enter the menu.
- Select the **Wi-Fi** option with the **Z (5) / C (3)** button.
- Briefly press of the **M (4)** button to turn Wi-Fi on.
- The device is recognized by an external device under the label 'Geni_XXXXX-XXXXXX', XXXXX-XXXXXX is the SN code of the device.
- Enter the password on an external device, and establish a connection.
The initial password is 12345678.
- And then, the device can be controlled through the InfiRay Outdoor.

Set Wi-Fi name and password

The Wi-Fi name and password of your device can be set in the APP.

- Click the "Setting" icon  in the APP to enter the setting interface.
- In the text box, enter and submit the name (SSID) and password of the new Wi-Fi.
- It needs to restart the device to take the new name and password effect.

18 Update and APP Technology

In order to continuously improve the product performance and provide better user experience, the software program, as well as parameters and operating instruction of the device will be constantly updated. Users can go to the official website (www.infirayouordoor.com) to download and update. The Geni series support APP technology, and can be connected to a smartphone or tablet PC via Wi-Fi for real-time image transmission, control operations, and program updates.

About InfiRay Outdoor

- You can download and install the **InfiRay Outdoor** app on www.infirayouordoor.com or App



- store. Otherwise, you can download the app by scanning the QR code.
- When installation completed, open **InfiRay Outdoor** application.
- If your device is already connected with a mobile device, please switch on the mobile data in mobile device. After connection, the update detection is performed automatically with a prompt in the application. Click '**Now**' to download the updates or click '**Later**' to update later.
- **InfiRay Outdoor** will automatically store the last connected device. So, if your device has not connected with your mobile device, but linked to **InfiRay Outdoor** before, the update prompt will appear if there is an update when turning on **InfiRay Outdoor**. You can download the update first via mobile Wi-Fi and then connect your device with mobile device to finish the update.
- After finishing the update, the device will root.
- Instructions for using **InfiRay Outdoor** can also be downloaded from the official website.

19 Technical Inspection

A technical inspection of the device is recommended before use.

- Check the external appearance of the device (there should be no cracks in the casing).
- Check the condition of the lens and eyepiece (there should be no cracks, greasy spots, dirt or other deposits)
- Check the condition of the rechargeable battery (this should be charged) and the electrical contacts (there should be no presence of salts or oxidation).

20 Maintenance

Maintenance should be carried out at least twice a year and consist of the following actions.

- Wipe the external surfaces of metal and plastic parts free of dust and dirt with a cotton cloth. Silicone grease maybe used for this.
- Clean the electrical contacts of the battery and battery slot on the unit using a non-greasy organic solvent.
- Check the glass surfaces of the eyepiece and the lens. If necessary, remove dust and sand from the lenses (preferably using a non-contact method). Cleaning of the external surfaces of the optics should be done

with substances designed especially for this purpose.

21 Legal and Regulatory Information

Wireless transmitter module frequency range:

WLAN: 2.412-2.472GHz (For EU)

Wireless transmitter module power<20dBm (only for EU)



IRay Technology Co., Ltd. thus declares that the Geni GL35 complies with the directives 2014/53/EU and 2011/65/EU. The full text of the EU declaration of



conformity as well as additional information are available at: www.infirayoutdoor.com.

This device may be operated in all member states of the EU.

FCC Statement

FCC-ID: 2AYGT-2H1

Labeling requirements

This device complies with part 15 of the FCC Rules. Operation is subject to the following two conditions: (1) This device may not cause harmful interference, and (2) this device must accept any interference received, including interference that may cause undesired operation.

Information to the user

Any Changes or modifications not expressly approved by the party responsible for compliance could void the user's authority to operate the equipment.

Note: The manufacturer is not responsible for any radio or TV interference caused by unauthorized modifications to this equipment. Such modifications could void the user's authority to operate the equipment.

Note: This equipment has been tested and found to comply with the limits for a Class B digital device, pursuant to part 15 of the FCC Rules. These limits are designed to provide reasonable protection against harmful interference in a residential installation. This equipment generates uses and can radiate radio frequency energy and, if not installed and used in accordance with the instructions, may cause harmful interference to radio communications. However, there is no guarantee that interference will not occur in a particular installation. If this equipment does cause harmful

interference to radio or television reception, which can be determined by turning the equipment off and on, the user is encouraged to try to correct the interference by one or more of the following measures:

- Reorient or relocate the receiving antenna.
- Increase the separation between the equipment and receiver.
- Connect the equipment into an outlet on a circuit different from that to which the receiver is connected.
- Consult the dealer or an experienced radio/TV technician for help.

This equipment complies with FCC RF radiation exposure limits set forth for an uncontrolled environment.

Body-worn Operation

This device was tested for typical body-support operations. To comply with RF exposure requirements, a minimum separation distance of 0.5cm must be maintained between the user's body and the handset, including the antenna. Third-party belt-clips, holsters, and similar accessories used by this device should not contain any metallic components. Body accessories that do not meet these requirements may not comply with RF exposure requirements and should be avoided. Use only the supplied or an

approved antenna.

We, IRay Technology Co., Ltd., hereby declare that this product was tested conforming to the applicable FCC rules under the most accurate measurement standards possible, and that all the necessary steps have been taken and are in force to assure that production units of the same equipment will continue to comply with the Commissions requirements.